

COBHAM

SAILOR 6282 AIS Transponder SAILOR 6280/6281 AIS System

User manual



SAILOR 6282 AIS Transponder SAILOR 6280/6281 AIS System

User Manual

Document number: 98-135323-C

Release date: March 12, 2014

Disclaimer

Any responsibility or liability for loss or damage in connection with the use of this product and the accompanying documentation is disclaimed by Thrane & Thrane A/S. The information in this manual is provided for information purposes only, is subject to change without notice and may contain errors or inaccuracies. Manuals issued by Thrane & Thrane A/S are periodically revised and updated. Anyone relying on this information should acquire the most current version e.g. from www.cobham.com/satcom > Service and support, or from the distributor. Thrane & Thrane A/S is not responsible for the content or accuracy of any translations or reproductions, in whole or in part, of this manual from any other source. Thrane & Thrane A/S is trading as Cobham SATCOM.

Copyright

© 2014 Thrane & Thrane A/S. All rights reserved.

Trademark Acknowledgements

- SAILOR is a registered trademark of Thrane & Thrane A/S in the European Union and the United States of America and other countries.
- Other product and company names mentioned in this manual may be trademarks or trade names of their respective owners.
- This product contains Android™ software. Android is a trademark of Google Inc.

GPL notification

The software included in this product contains copyrighted software that is licensed under the GPL/LGPL. The verbatim licenses can be found online at:

<http://www.gnu.org/licenses/old-licenses/gpl-2.0.html>

<http://www.gnu.org/licenses/old-licenses/lgpl-2.1.html>

You may obtain the complete corresponding source code from us for a period of three years after our last shipment of this product, which will be no earlier than 2021, by sending a money order or check for DKK 50 to:

SW Technology/GPL Compliance,

Thrane & Thrane A/S,

Lundtoftegaardsvej 93D

2800 Lyngby

DENMARK

Write "source for product SAILOR 6282 AIS Transponder" in the memo line of your payment. This offer is valid to anyone in receipt of this information.

[https://www.cobham.com/about-cobham/aerospace-and-security/about-us/satcom/free-and-open-source-software-\(foss\).aspx](https://www.cobham.com/about-cobham/aerospace-and-security/about-us/satcom/free-and-open-source-software-(foss).aspx)

Safety summary

Observe the following general safety precautions during all phases of operation, service and repair of this equipment. Failure to comply with these precautions or with specific warnings elsewhere in this manual violates safety standards of design, manufacture and intended use of the equipment. Thrane & Thrane A/S assumes no liability for the customer's failure to comply with these requirements.

Ground the equipment

To minimise shock hazard, connect the SAILOR 6282 AIS Transponder to an electrical ground and follow the cable instructions.

RF exposure hazards and instructions

The SAILOR unit generates electromagnetic RF energy when transmitting. To ensure that you and those around you are not exposed to excessive amounts of energy and to avoid health hazards from excessive exposure to RF energy, all persons must be at least 0.2 m away from the antenna when the unit is transmitting.

Warranty limitation

IMPORTANT - The SAILOR 6285 GPS Antenna – Active is a sealed waterproof unit (classified IPx6 & IPx8). To create and maintain its waterproof integrity it was assembled in a controlled environment using special equipment. The SAILOR 6282 AIS Transponder is not a user maintainable unit, and under no circumstances should the unit be opened except by authorized personnel. Unauthorized opening of the unit will invalidate the warranty.

Installation and service

Installation and general service must be done by skilled service personnel.

Compass safe distance

Compass safe distance: 55 cm (Standard magnetic compass), 45 cm (Emergency magnetic compass) from the SAILOR 6282 AIS Transponder or the SAILOR 6283 AIS Connection Box and Wall Tray.

Preface

Approvals

The SAILOR 6282 AIS Transponder fulfills the requirements of the Marine Equipment Directive 96/98/EC with 8th amend 2012/32/EU and is intended for use in maritime environment.

The SAILOR 6282 AIS Transponder is approved to MED 2011/75/EU and fulfills the requirements in the standards: IEC 61993-2 (2012), IEC 60945 ed.4 (2002), ITU-R M.1371-4, IEC 61162-1 (2010), IEC61162-2 (1999).

The SAILOR 6282 AIS Transponder is approved to FCC CFR47 part 80 with USCG approval no. 165.155/0168/BABT/MED000046/0575.

The SAILOR 6282 AIS Transponder is approved for Inland AIS according CCNR VTT Standard Ed. 1.2 and Inland AIS Test standard De 2.0.

The SAILOR 6282 AIS Transponder is approved to IC and fulfills the requirements in RSS-182.

The approvals of the SAILOR 6282 AIS Transponder are constantly monitored. New national approvals will be applied for and granted and new test standards may come into force.

Therefore the above list may not be complete. Contact your authorized dealer for more information.

Training information

The SAILOR 6282 AIS Transponder is designed for *occupational use only* and is also classified as such. It must only be used in the course of employment by individuals aware of the hazards as well as the way to minimize those hazards.

The unit is thus NOT intended for use in an uncontrolled environment by general public. The SAILOR 6282 AIS Transponder has been tested and complies with the FCC RF exposure limits for *Occupational Use Only*. The unit also complies with the following guidelines and standards regarding RF energy and electromagnetic energy levels including the recommended levels for human exposure:

- FCC OET Bulletin 65 Supplement C, evaluating compliance with FCC guidelines for human exposure to radio frequency electromagnetic fields.
- American National Standards Institute (C95.1) IEEE standard for safety levels with respect to human exposure to radio frequency electromagnetic fields, 3 kHz to 300 GHz.
- American National Standards Institute (C95.3) IEEE recommended practice for the measurement of potentially hazardous electromagnetic fields - RF and microwaves.

Below is a description of the RF exposure hazards and instructions in safe operation of the unit within the FCC RF exposure limits established for it.

Warning

Your SAILOR unit generates electromagnetic RF (radio frequency) energy when it is transmitting. To ensure that you and those around you are not exposed to excessive amounts of that energy (beyond FCC allowable limits for occupational use) and thus to avoid health hazards from excessive exposure to RF energy, FCC OET bulletin 65 establishes a Maximum Permissible Exposure (MPE) radius of 0.2 m for the maximum power of your unit (12.5 W selected) with a half wave omni-directional antenna having a maximum gain of 3 dB (5.2 dBi). This means all

persons must be at least 0.2 m away from the antenna when the unit is transmitting.

Alerte de Sécurité

Dangers liés à l'exposition aux fréquences radio et instructions. Conformément à la réglementation d'industrie Canada, le présent radio émetteur ne peut fonctionner qu'avec une antenne de type omnidirectionnelle, demi-onde ou d'un gain maximale de 3 dB, approuvée par Industrie Canada. Pour éviter les risques pour la santé dûs à une exposition excessive aux champs de fréquences radio, une distance minimale de 0.2 m est nécessaire entre l'utilisateur et le radio-émetteur.

Installation

The SAILOR 6282 AIS Transponder is designed for installation by a skilled service person.

1. An omni-directional antenna with a maximum power gain of 5.2 dBi must be mounted at least 2.2 m above the highest deck where people may be staying during radio transmissions. The distance is to be measured vertically from the lowest point of the antenna. This provides the minimum separation distance which is in compliance with RF exposure requirements and is based on the MPE radius of 0.2 m plus the 2 m height of an adult.
2. On vessels that cannot fulfill requirements in item 1, the antenna must be mounted so that its lowest point is at least 0.2 m vertically above the heads of people on deck and all persons must be outside the 0.2 m MPE radius during radio transmission.
 - Always mount the antenna at least 0.2 m from possible human access.
 - Never touch the antenna when transmitting
 - Use only authorized SAILOR accessories.
3. If the antenna has to be placed in public areas or near people with no awareness of the radio transmission, the antenna

must be placed at a distance not less than 1.8 m from possible human access.

Failure to observe any of these warnings may cause you or other people to exceed FCC RF exposure limits or create other dangerous conditions.

About the manual

Intended readers

This manual is a user manual for the SAILOR 6282 AIS Transponder system. This manual is intended for anyone who is using or intends to use this system. No specific skills are required to operate the SAILOR 6282 AIS Transponder. However, it is important that you observe all safety requirements listed in the beginning of this manual, and operate the system according to the guidelines in this manual.

Note that this manual does not cover installation of the system. For information on installation refer to the installation manual. Part numbers for related manuals are listed in the next section.

Related documents

The following table shows the documents related to this manual and to the SAILOR 6282 AIS Transponder.

Title and description	Document number
SAILOR 6280/6281 AIS System, Installation manual	98-137573
SAILOR 6004 Control Panel, Installation manual	98-136644
SAILOR 6282 AIS Transponder, Installation guide	98-136017
SAILOR 6283 AIS Connection Box and Wall Tray, Installation guide	98-136018
SAILOR 6285 GPS Antenna - Active, Installation guide	98-136019

Typography

In this manual, typography is used as indicated below:

Bold is used for the following purposes:

- To emphasize words.
Example: “Do **not** touch the antenna”.
- To indicate what the user should select in the user interface.
Example: “Select **SETTINGS** > **LAN**”.

Italic is used to emphasize the paragraph title in cross-references.

Example: “For further information, see *Connecting Cables* on page...”.

Table of contents

Chapter 1 Introduction

Introduction to AIS	1
The SAILOR 6280/6281 AIS System	4
System components	6

Chapter 2 Operation

To get started	9
Settings	15
To work with messages	33
Alarms and notifications	39
List of alarms	41

Chapter 3 Service & maintenance

Maintenance	49
Troubleshooting guide	56
Service and repair	58

App. A Specifications

SAILOR 6282 AIS Transponder	61
SAILOR 6285 GPS Antenna - Active	64
SAILOR 6283 AIS Connection Box and Wall Tray	65
SAILOR 6004 Control Panel	65

App. B	NMEA sentences	
	Sentences defined in IEC 61993-2	67
	Sentences defined by Cobham SATCOM	67
Glossary	69
Index	73

Introduction

This chapter introduces the SAILOR 6282 AIS Transponder and gives an overview of the system and services. It has the following sections:

- *Introduction to AIS*
- *The SAILOR 6280/6281 AIS System*
- *System components*

Introduction to AIS

Overview

AIS (Automatic Identification System) is a communication system for the exchange of navigation data. An AIS station can be a ship station or a shore-side base station. AIS stations operate without interaction by ship or shore personnel (autonomous and continuous). AIS has evolved to include devices such as AIS as a navigation aid, AIS on search and rescue aircraft and AIS search and rescue transmitters (AIS SART).

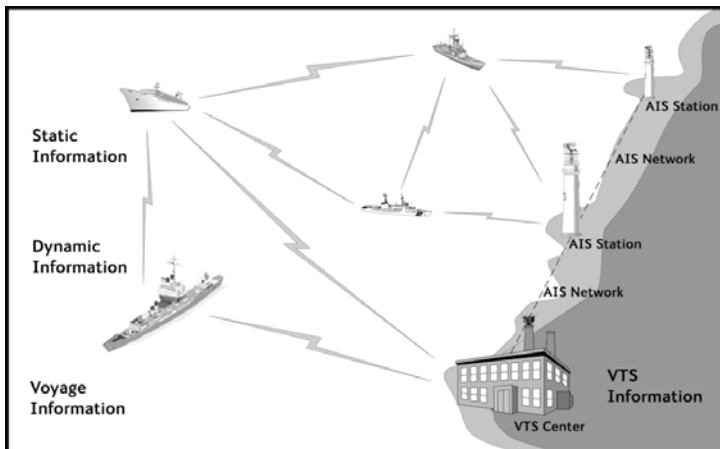

Figure 1: AIS for exchange of data

AIS enables the automatic exchange of shipboard information from the vessel's sensors (dynamic data), as well as manually entered static and voyage related data, between one vessel and another and between a vessel and a shore station(s). AIS also provides the possibility to send short safety related text messaging for ship or shore personnel. AIS devices are required internationally on most commercial vessels as identified by the International Maritime Organization (IMO) in the Safety of Life at Sea Convention (SOLAS), Chapter V. In addition, AIS is often required domestically on other vessels by some administrations.

AIS applications and purpose

The principal applications of AIS are:

- Information exchange between vessels within VHF range of each other, increasing situation awareness
- Information exchange between a vessel and a shore station, such as a Vessel Traffic Service (VTS), to improve traffic management in congested waterways
- Automatic reporting in areas of mandatory and voluntary reporting
- Exchange of safety related information between vessels and between vessels and shore station(s).

The purpose of AIS is to improve the safety of navigation and protection of the environment by assisting in the effective navigation of ships and the operation of VTS. This is achieved through the following:

- In a ship-to-ship mode for collision avoidance
- As a means for littoral states to obtain information about a ship and its cargo
- As a VTS tool, i.e. ship-to-shore, for traffic management
- Increased situational awareness which enables effective response to emergencies such as search and rescue (SAR) as well as environmental pollution
- Providing data to identify trends or improvements to enhance navigational safety.

Note

Not all ships are required to have AIS. Furthermore, AIS may be switched off if there is a potential risk that the operation of AIS might compromise the safety or security of the ship, or if security incidents are imminent.

If a vessel operating in a mandatory ship reporting system does switch off its AIS, this should be reported to the relevant authority. Note that some data is entered or updated manually, meaning that there is potential for false entry and for the entered data to become out of date. This includes data related to static information (e.g. ship identity, dimension) and voyage related data (e.g. navigational status).

AIS and radar

A difference between AIS and radar is that AIS uses an absolute referencing system to determine the position, whereas radar determines the position by relative measurements from the vessel or shore base to observed targets. AIS may be used together with radar information to provide:

- Vessel identification, heading, course over ground (COG) and speed over ground (SOG)
- Improved vessel tracking (no target swap)
- Wider geographical coverage
- Greater positional accuracy, dependent on the position input sensor
- Information in radar shadow area ('sees' around bends and behind islands)
- Maneuver data in nearly real time
- No loss of targets in sea, rain and snow clutter

AIS classes

AIS is not only used on board ships. It can be grouped by 'class' (shipborne) and function. A Ship borne AIS device which contributes by most of the flow of AIS information, is classified as either Class A, B or Inland AIS. The AIS Class A stations are ship borne units which meet IMO performance standards and are required on most commercial ships by the International Maritime organization (IMO). The SAILOR 6282 AIS Transponder is a combined Class A and Inland AIS station.

The SAILOR 6280/6281 AIS System

The SAILOR 6280 AIS System consists of the following units:

1. SAILOR 6282 AIS Transponder
2. SAILOR 6285 GPS Antenna - Active
3. SAILOR 6004 Control Panel
4. SAILOR 6283 AIS Connection Box and Wall Tray

The SAILOR 6281 AIS Basic System consists of the following units:

1. SAILOR 6282 AIS Transponder
2. SAILOR 6285 GPS Antenna - Active
3. SAILOR 6004 Control Panel

Overview of a SAILOR 6281 AIS Basic System

The following figure shows the system configuration.

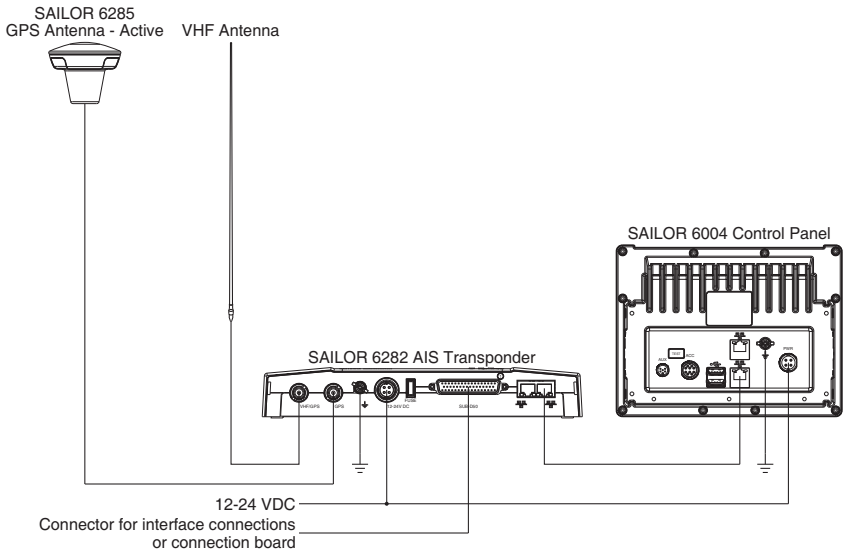

Figure 2: System configuration for the SAILOR 6281 AIS Basic System

The SAILOR 6004 Control Panel is connected to the SAILOR 6282 AIS Transponder through a LAN connection (LWE/IEC 61162-450), here after called LWE. The SAILOR 6281 AIS Basic System is operated using the touch display of the SAILOR 6004 Control Panel.

Features

- AIS Class A compliant and approved
- Inland AIS compliant and approved
- Active GPS antenna included
- Interface for ThraneLINK applications and INS available
- Programmable interface for connection to sensors using the NMEA interface versions 2.0, ...,4.1
- Touch screen on the SAILOR 6004 Control Panel

- Easy installation with the dedicated connection box available (SAILOR 6283 AIS Connection Box and Wall Tray)
- Easy service - on the unit, through the ThraneLINK Management Application (TMA) or a web browser
- Built-in self-diagnostic system
- Built-in DC output on GPS antenna connector
- Possibility for a combined VHF and GPS antenna
- River use compliant with CCNR requirements
- Works with both GPS and GLONASS
- Input for Low Power Forced Control, 1W output (gas alarm)
- Support of Class B carrier sense messages
- Function for discarding Class B messages
- Support for Long Range satellite tracking on channel 75 & channel 76
- Interface for pilot plug

System components

SAILOR 6282 AIS Transponder

The SAILOR 6282 AIS Transponder is a combined Class A and Inland AIS station. It has connectors for GPS and VHF antenna, a ground stud, connector for DC power (12–24 VDC), multi connector for interfaces and 2 LAN connectors. The SAILOR 6282 AIS Transponder is always on, provided there is DC power.

The SAILOR 6282 AIS Transponder supports 3 sensor inputs for e.g. GPS and ROT and 4 presentation interfaces for e.g. ECDIS, Radar, Long Range and Pilot Plug. It also has inputs for Blue Sign functionality, Low Power Forced Control (gas alarm) and output for alarm. The SAILOR 6282 AIS Transponder has three LEDs showing the status of Power, Rx and Tx.



Figure 3: SAILOR 6282 AIS Transponder

SAILOR 6285 GPS Antenna - Active

The SAILOR 6285 GPS Antenna - Active is a robust, sealed and waterproof GPS antenna (classified IPx6 & IPx8).



Figure 4: SAILOR 6285 GPS Antenna - Active

SAILOR 6004 Control panel

The SAILOR 6004 Control panel is the user interface for the SAILOR 6282 AIS Transponder. Through the touch panel you access all settings that can be changed by the user. Alarms and notifications are shown in the display. The SAILOR 6004 Control panel has a buzzer for alarm tones. The display supports night mode. The AIS application is loaded into the SAILOR 6004 Control Panel during installation.



Figure 5: SAILOR 6004 Control panel

SAILOR 6283 AIS Connection Box and Wall Tray (optional)

The SAILOR 6283 AIS Connection Box and Wall Tray has spring-loaded terminals for easy connection of all interfaces. See *SAILOR 6282 AIS Transponder* on page 6 for more information on interfaces.

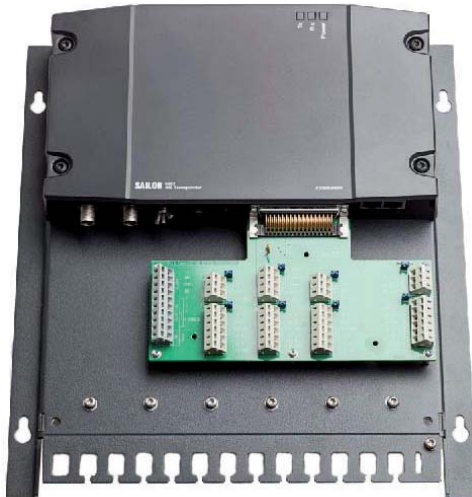

Figure 6: SAILOR 6283 AIS Connection Box and Wall Tray

Operation

This chapter has the following sections:

- *To get started*
- *Settings*
- *To work with messages*
- *Alarms and notifications*

To get started

As soon as DC power is provided the SAILOR 6282 AIS Transponder is on.

To switch on the SAILOR 6004 Control Panel push the power button. Operate the SAILOR 6004 Control Panel by tapping the touch screen. To switch off the SAILOR 6004 Control Panel push and hold the power button for 2 seconds and follow the instructions on the screen.

**Note**

When the remote switch in the SAILOR 6004 Control Panel is wired and it is switched on, you can only use the Power button to reboot the SAILOR 6004 Control Panel, you cannot switch it off.

The AIS application has been installed during the installation of the SAILOR 6280/6281 AIS System. To start the AIS application tap the **AIS** icon in the display of the SAILOR 6004 Control Panel.

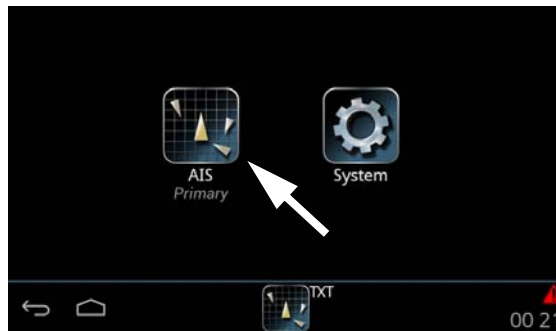

Figure 7: Screen after start-up (example)

The icon **System** holds the application manager and settings for the SAILOR 6004 Control panel, for more details see *App installation and system settings* on page 52.

AIS screen

The AIS app has the following idle screen:



Figure 8: Sections in the AIS application screen (example)

1. Top bar



- Current app, in this case AIS, showing the name of the SAILOR 6282 AIS Transponder.
- Tab **List** showing a list of ships near own ship.
- Tab **Messages** showing all messages received and sent.
- Icon for sending messages and **Settings**.

2. AIS app-specific area

This image shows a close-up of the ship list table from the AIS application. The table has columns for 'Details', 'BRG', 'RNG', 'Ship', and 'Age'. It lists several ships with their respective bearings, ranges, names, and ages.

Details	BRG	RNG	Ship	Age
	063°	10.1	URANIBORG	0
	012°	14.7	TYCHO BRAHE	0
	156°	15.5	TRICA	0
	154°	5.6	SVITZER MARS	0

Each row represents a ship and its position relative to own ship.

- **Details** – tap to display a new screen with details for the selected ship.
- **BRG** shows the current bearing value to own ship.
- **RNG** shows the current distance (range) in nautical miles (NM) between own ship and ship in the AIS list.

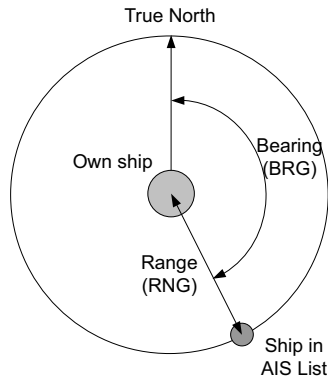

Figure 9: Bearing and range

- **Age** shows the number of minutes since this ship last reported data.

The list holds up to 200 targets within VHF range which are closest to own ship. A ship is cleared from the list after 7-18 minutes. You can sort the list, see *Sorting the list of ships* on page 13.

3. Bottom bar



- Icon for back function and collapsing the on-screen keyboard.
- Icon for going to the start screen.

- Icons for apps that are operated from this SAILOR 6004 Control Panel, including status information.

Letters next to AIS icon	Status information
LR	There are unread Long Range messages. For more information see page 25.
TXT	The Status information has changed. For more information see page 20.
LO	The AIS unit is in low-power mode (Low power forced control (gas alarm)).
✘	Red icon. The AIS unit is in Silent Mode and the transmitter is disabled. For more information see page 31.

Table 1: Letters next to the AIS icon in the bottom bar

- Icon for unread messages, if any.
Unread safety messages are marked with a red exclamation mark.
- Icon for alarms present: from any unit controlled by this SAILOR 6004 Control Panel:
 - Flashing bright red triangle: Unacknowledged alarm(s).
 - Faded red triangle: Acknowledged alarm(s).
- UTC time, received from GPS receiver.

Sorting the list of ships

You can sort the list of ships by selecting the heading of the column you want to sort by. Select it again to toggle between ascending and descending order.



Figure 10: Sorting the list of ships (example)

Dim and night mode

Turn the dim knob of the SAILOR 6004 Control Panel to increase or decrease the display brightness. The display goes into night mode either when turning the dim knob on the front panel counterclockwise or when the internal light sensor detects the light level for changing to night mode.

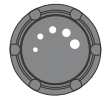

To dim to level zero push the power button once. If an alarm appears while the display is in level zero, the display returns to the latest dim value and the alarm is displayed.

Show the ship details

The SAILOR 6282 AIS Transponder provides details for all ships listed. On the idle screen, tap the ship that you are interested in. Swipe upwards to display further items.

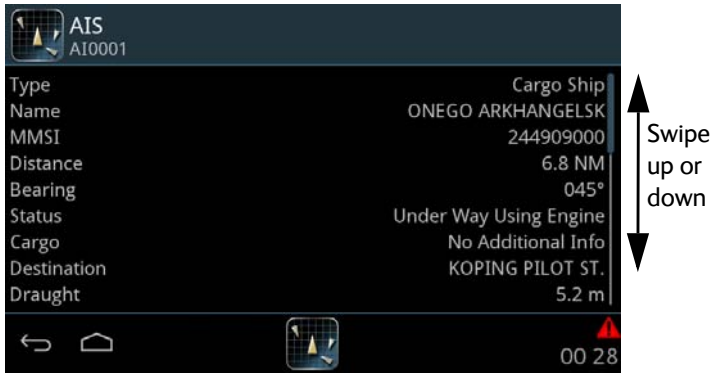

Figure 11: Ship details

Settings

To access the settings of the SAILOR 6282 AIS Transponder tap the menu icon and **Settings**.

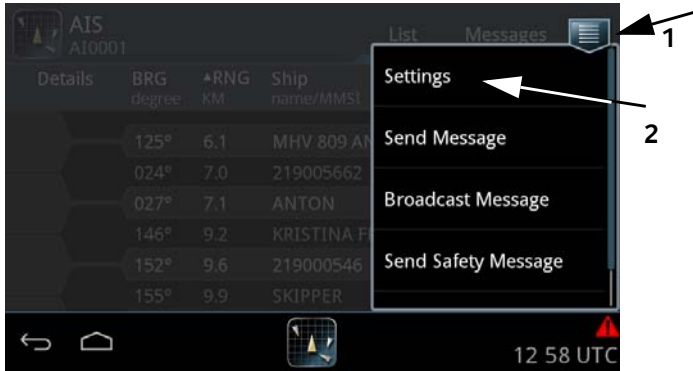

Figure 12: Accessing **Settings**

This menu has the following items:

- *Voyage*
- *Dynamic Data (read only)*
- *Status (read only)*
- *Static Data (read only)*
- *Inland Waterways*
- *Long Range*
- *Test Message*
- *Channel Management*
- *Connection (read only)*
- *Internal GNSS (read only)*
- *Silent Mode*

Note Only touch-screen keys that are required by the AIS standard 1371-4 table 44 are supported. Other keys are ignored.

Password protection

A number of settings is password protected against unauthorised or accidental use. They are marked with a padlock.

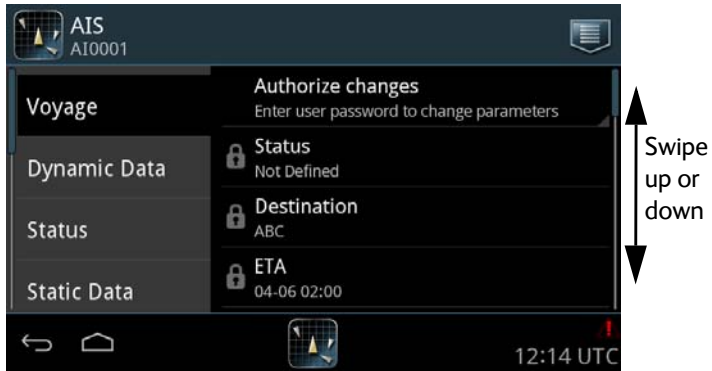

Figure 13: Password protection – example

To unlock a page with password protected parameters do as follows:

1. Tap the first line on the page: **Authorize changes**.
2. Enter the user level password (default: user). If the password user does not work, contact your installation center. The user password might have been changed.
3. Tap **Done**.
4. Tap **Apply**.
5. The padlocks are opened and you can change a parameter.

When leaving the page, the parameters are locked again.

Voyage

Here you select or enter the various items for the ship's current voyage. Swipe upwards to display further items. Some of the parameters are only visible if Inland Waterways has been enabled. These parameters may have been set up during installation.

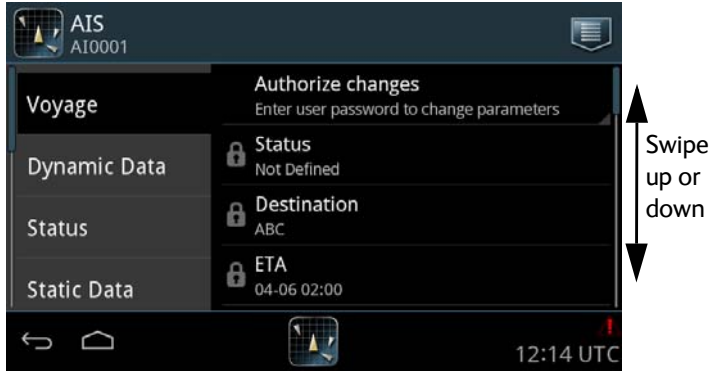

Figure 14: Settings – **Voyage**

To change the parameters do as follows:

1. Unlock the page by entering the password.
2. Tap the parameter you want to change and follow the instructions in the display.

Item	Description
Status	Tap the field Status and set one option.
Destination	Tap the field Destination and enter the destination using the keyboard on the screen. Tap OK to accept.
ETA	Tap the field ETA to enter the estimated time of arrival. Format: mm-dd hh:mm. Tap Done . If ETA is not known, enter xx.
Cargo	Tap the field Cargo and set one option.

Table 2: Items in **Voyage**

Item	Description
Draught ^a	Tap the field Draught and select the draught of ship xx.x m (0–20).(0–9). Tap Done .
Persons on board ^a	Number of crew members, passengers and shipboard personnel on board.
ERI ship type ^b	ERI ship type according to ERI classification, swipe the list and select the ship type.
Crew Members ^b	Number of crew members on board (0 to 8190).
Passengers ^b	Number of passengers on board (0 to 254).
Shipboard Personnel ^b	Number of shipboard personnel on board (0 to 254).
Static Draught ^b	Static draught of ship (0 to 20,00 m).
Air draught ^b	Air draught of ship (0 to 40,00 m).
Tug Boats ^b	Number of assisting tugboat (0-6).
Blue Cones ^b	Number of blue cones (for cargo classification), 1, 2 or 3 Blue Cones, B-Flag or Unknown.
Blue Sign ^b	Set automatically by a connected switch or a PI sentence.: Not available, Not set or Set.
Loaded ^b	Set to: Not available, Loaded or Not Loaded
Convoy Bow ^b	Convoy extension to bow in m.dm (resolution in dm).
Convoy Stern ^b	Convoy extension to stern in m.dm (resolution in dm).
Convoy Port ^b	Convoy extension to port side in m.dm (resolution in dm).
Convoy Starboard ^b	Convoy extension to starboard side in m.dm (resolution in dm).

Table 2: Items in **Voyage** (Continued)

- a. Visible if Inland Waterways is disabled.
- b. Visible if Inland Waterways is enabled, see also Figure 18 on page 23.

Dynamic Data (read only)

The dynamic data is provided by the ship's sensors.

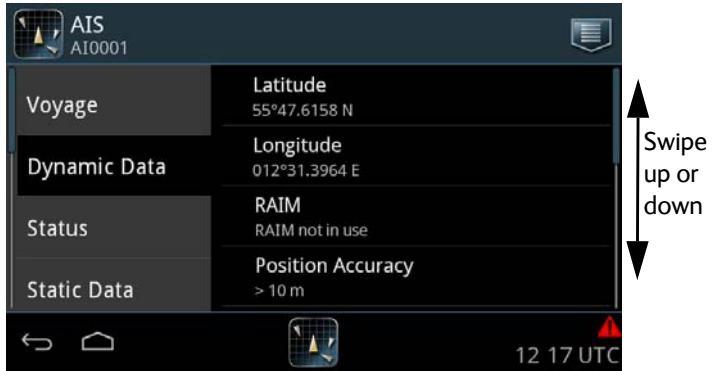

Figure 15: Settings – **Dynamic data** (read only)

Item	Description
Latitude	Current value for latitude.
Longitude	Current value for longitude.
RAIM	Indication of RAIM being used or not.
Position accuracy	> 10 m or <= 10 m.
Position quality	Indication of position quality derived from Position accuracy, RAIM and Position time stamp.
Time stamp	Time stamp for latest received position update in seconds.
COG	Course over ground, relative to True North.
SOG	Speed over ground.
Heading	1 – True North 2 – Heading
Rate of turn	Right or left, from 0 to 720 degrees per minute.

Table 3: Items in **Dynamic Data**

Status (read only)

The items on this page show the current status of a couple of parameters.



Figure 16: Settings – **Status**

Item	Description
GNSS	Type of position input: AIS: External GNSS in use AIS: Internal GNSS in use AIS: External DGNSS in use
SOG/COG	AIS: External SOG/COG in use AIS: Internal SOG/COG in use
Heading	Current Heading input
ROT	Current Rate Of Turn
Channel Management	If the AIS Transponder enters a received regional area, TXT is shown next to the AIS icon in the bottom bar. You can then tap the menu icon > Settings > Status and see the Channel Management change. For viewing the regional area in use tap Channel Management . Once you have viewed this information, this field is cleared and the TXT is removed from the AIS icon in the bottom bar.

Table 4: Items in **Status**

Static Data (read only)

The static data is entered during installation.

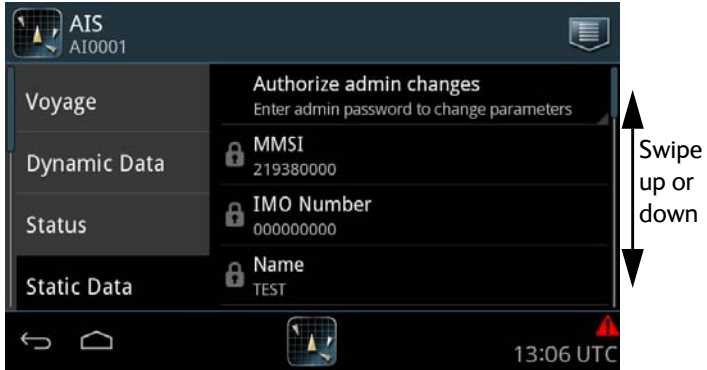

Figure 17: Settings – **Static data** (read only)

Item	Description
MMSI	Nine digit number to uniquely identify own ship.
IMO Number	A unique identifier consisting of the three letters IMO followed by a unique seven-digit number assigned to own ship.
Name	Name of own ship.
Callsign	Designation of this transmitting station.
EPFS Type	Type of Electronic Position Fixing System installed on own ship.
Ship Type	Type of own ship.
Numeric ship type	Type of own ship.
ENI Number ^a	ENI number of own ship
Length ^a	Overall length of own ship.
Beam ^a	Width at the widest point.

Table 5: Items in **Static Data**

Item	Description
Internal antenna ^b A, B, C and D	Physical location of the internal GNSS sensor, e.g. SAILOR 6285 GPS Antenna - Active, connected directly to the GPS antenna connector of the SAILOR 6282 AIS Transponder.
External antenna ^b A, B, C and D	Physical location of the external GNSS sensor on own ship, i.e. the antenna for the main GPS receiver that is connected to a sensor input of the SAILOR 6282 AIS Transponder.
Quality of speed information ^a	High or low. Consult the documentation of the connected speed sensor.
Quality of course information ^a	High or low. Consult the documentation of the connected course sensor.
Quality of heading information ^a	High or low. Consult the documentation of the connected heading sensor.

Table 5: Items in **Static Data** (Continued)

- a. Inland Waterways is enabled.
- b. Only B and C available when Internal Waterways is enabled.

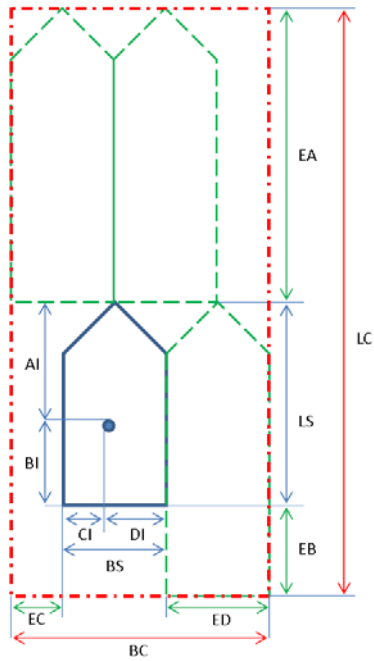

Figure 18: Physical location of GNSS sensor on the ship and in a convoy

Inland Waterways

On this page you enable the settings for **Inland Waterways** shown in **Voyage** and **Static Data**, and you can broadcast the number of persons on board, if requested to do so.

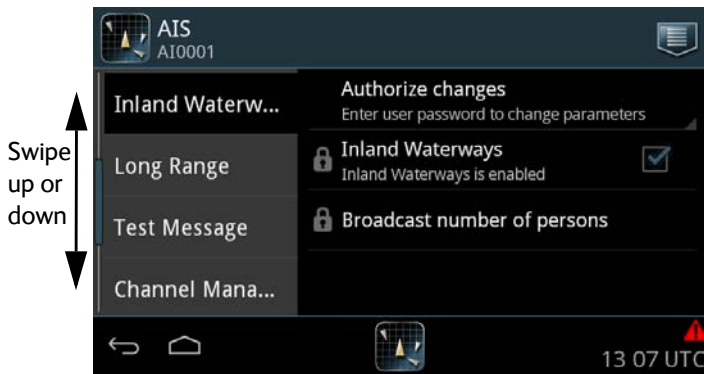

Figure 19: Settings – **Inland Waterways**

To enable Inland Waterways do as follows:

1. Unlock the page by entering the password.
2. Tap **Inland Waterways** to enable it.

When enabled, further fields will be available in **Voyage** and **Static Data**.

To broadcast the number of persons on board (this is the total number of persons: crew members, shipboard personnel and passengers) do as follows:

1. Unlock the page by entering the password 'user'.
2. Tap **Broadcast number of persons**.
3. At **Broadcast persons onboard** tap **Send**.

Long Range

The SAILOR 6282 AIS Transponder can broadcast long range messages. You can manually set which information to include in the long range message. Swipe upwards to display further items.

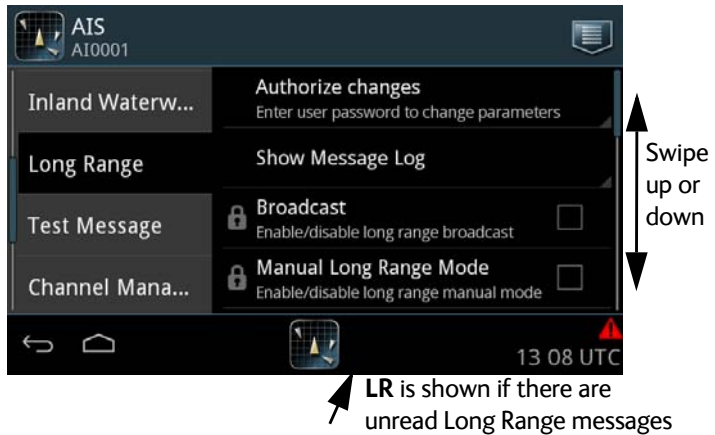

Figure 20: Settings – Long Range

To change a parameter do as follows:

1. Unlock the page by entering the password.
2. Tap the parameter you want to change and follow the instructions in the display.

Item	Description
Show Message Log	Tap here to display the log of received long range messages.
Broadcast	Tap Broadcast to enable or disable broadcast of long range messages.

Table 6: Items in Long Range

Item	Description
Manual Long Range Mode	<p>Tap Manual Long Range Mode to enable or disable long range manual mode. If enabled, tap the items to include in the long range message:</p> <ul style="list-style-type: none"> • Name, callsign and IMO (A) • Date and time of message (B) • Position (C) • Course over ground (E) • Speed over ground (F) • ETA and Destination (I) • Draught (O) • Ship/Cargo (P) • Length, breadth and type (U) • Persons on board (W) <p>The letter in parentheses is displayed in the LR message log.</p>

Table 6: Items in **Long Range** (Continued)

To clear the list of received Long Range messages (Long Range Message Log) Tap **Show Message Log** and then **Clear**.

Item	Description
From	MMSI number of the ship that has broadcasted the long range message.
Req.	Items requested by the AIS base station.
Sent	Items sent.

Table 7: Items in **Long Range Message Log**

Test Message

Use **Test Message** to check that the SAILOR 6282 AIS Transponder can send a text message to and receive a text message from other transponder systems. This test is done automatically. No action from the message recipient is required. A target with a suitable range (15-25 NM) is selected if such a target has been received by the SAILOR 6282 AIS Transponder. The SAILOR 6282 AIS Transponder supports **AIS SART Test** messages and **COM Test** messages.

To receive an **AIS SART Test** do as follows:

1. Unlock the page by entering the password.
2. Tap the **AIS SART Test** selection box to enable the display of AIS SART Test targets.

To start a COM Test do as follows:

1. Tap the **COM Test Target** to select a target for testing communication. This target responds by an automatic acknowledge from the displayed MMSI number. For each tap the test target changes because there are some rules to be followed (e.g. the AIS Transponder may not select closest or most distant target, it must toggle to new target after test message is sent for new test message)
2. Tap **Start COM Test**. The test starts and the result of the communication test is shown on the screen.

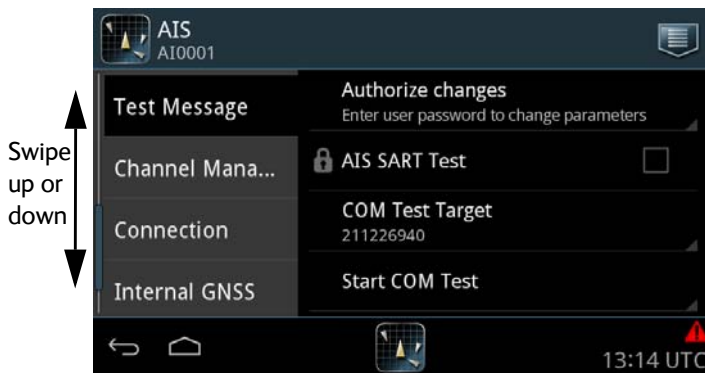

Figure 21: Settings – Test Message (example)

Channel Management

The AIS channel is preset. If required, the AIS parameters (up to 8 sets) can be changed. The AIS parameters can be changed as follows:

- AIS message 22 with new parameters (set automatically in the SAILOR 6282 AIS Transponder).
- Through a received DSC message with new parameters (set automatically in the SAILOR 6282 AIS Transponder).
- Manual input of new parameters, e.g. you have received the new parameters in a text message or via VHF radio.

The SAILOR 6282 AIS Transponder decides which of the frequencies to use.

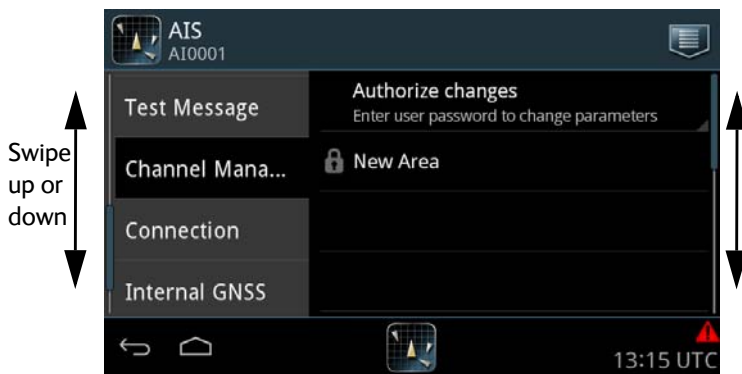

Figure 22: Settings – Channel Management

Entering new AIS parameter set manually

To enter a new area do as follows:

1. Unlock the page by entering the password.
2. Tap **New Area** and fill in the following parameters:
 - Set Area
 - NE Latitude
 - NE Longitude

- SW Latitude
- SW Longitude
- Channel A Frequency
- Channel A RX
- Channel A TX
- Channel B Frequency
- Channel B RX
- Channel B TX
- Transition zone
- High Power

Connection (read only)

The connection data is entered during installation.



Figure 23: Settings – Connection

Item	Description
Own Device Name	Identification of the SAILOR 6004 Control Panel in the network.
Remote Device Name	Identification of the SAILOR 6282 AIS Transponder in the network.
Remote IP	IP address of the connected SAILOR 6282 AIS Transponder. The IP address is needed for setup, service and maintenance. The IP address is acquired automatically (read only).
Own IP	IP address of the SAILOR 6004 Control Panel. The IP address is needed for service and maintenance. The IP address is acquired automatically (read only).

Table 8: Items in **Connection**

Internal GNSS (read only)

You can view the current signal levels from the GPS satellites.

Tap **Internal GNSS**.



Figure 24: Settings – Internal GNSS

Silent Mode

Use Silent Mode only if it is necessary to be invisible, e.g. in a pirate situation in international waters.

Important

Enabling Silent Mode violates the IMO regulation for GMDSS.

Using Silent Mode will make your vessel non-compliant to the IMO carriage requirements and is only allowed under special circumstances. This action must be recorded in the ship's log.

If no functional switch is connected¹ to the SAILOR 6282 AIS Transponder you can activate Silent Mode in a menu on the SAILOR 6004 Control Panel.

A warning appears in a popup window on the SAILOR 6004 Control Panel and an alarm (TX disabled) is logged². The popup window will be repeated every twelfth hour as a reminder that the Silent Mode is still active. The Silent Mode is active after power interruption until it is manually disabled. When leaving the Silent Mode a warning appears on the SAILOR 6004 Control Panel that the ship is visible again².

The SAILOR 6282 AIS Transponder cannot acknowledge received addressed messages in Silent Mode because all transmit activity is disabled in Silent Mode. Therefore the sender will retransmit the message several times and the SAILOR 6282 AIS Transponder will display all retransmitted messages.

-
1. In the Service Interface, the IO settings for the functional switch must be set to Not Used or Blue Sign.
 2. Only with external switch for Silent Mode.

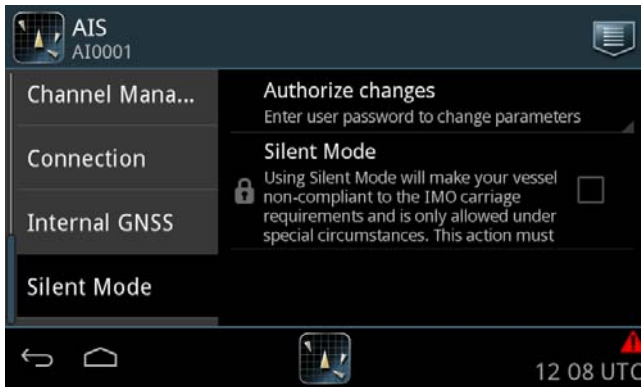

Figure 25: Settings – Silent Mode

To enable Silent Mode do as follows:

1. Unlock the page by entering the password.
2. Tap the selection field to enable Silent Mode.
3. Tap the popup window Safety alarm to acknowledge Silent Mode.
4. Tap the arrow in the bottom left corner to return to the ship list.

To disable Silent Mode do as follows:

1. Unlock the page by entering the password.
2. Tap the selection field to disable Silent Mode.
3. Tap the arrow in the bottom left corner to return to the ship list.

To work with messages

Overview

You can send, broadcast and receive text messages and safety-related messages (SRM) to and from all ships within VHF range. An unread message is shown as a closed envelope in the bottom bar of the screen. An envelope with an exclamation mark is a SART message. White envelopes mean that new messages have arrived since you last tapped the area for messages in the lower right corner. Gray envelopes mean that no new messages have arrived since you last tapped the area for messages.

To view all messages tap the tab **Messages** in the idle screen.

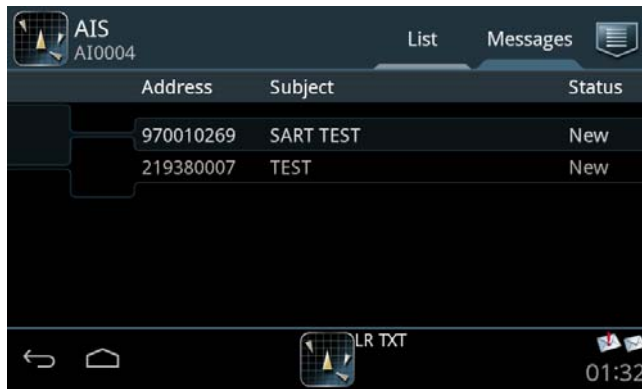

Figure 26: The tab **Messages**

The latest 20 addressed safety-related messages are stored (minimum). Broadcast safety-related messages (e.g. SART) are updated continuously, the newest one is stored and can be displayed. The oldest messages are overwritten.

There are two ways of sending a message:

- Sending a message to a dedicated address (MMSI number)
- Broadcasting a message to all listeners.

Sending and broadcasting messages

To send or broadcast a message or safety message, do as follows:

1. Tap the icon for **Messages**.
2. Select which type of message you want to send. A message can be addressed to a specific MMSI number (Send.....) or to all listeners (Broadcast.....). The content of a message can be ordinary text or a safety message.

Unread messages are indicated as a closed envelope icon. Unread safety messages pop up on the screen on arrival.

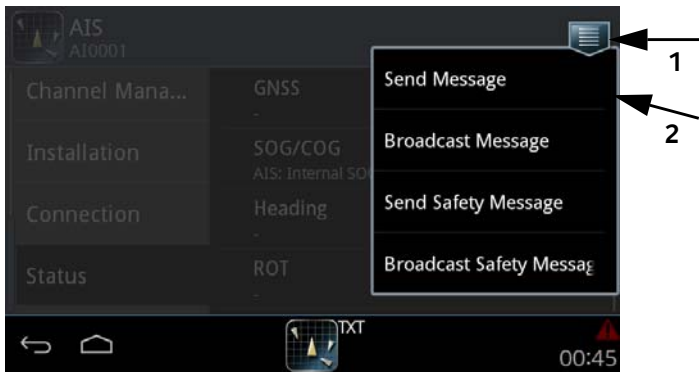

Figure 27: Message types

3. Tap the address field and enter the MMSI number of the ship using the on-screen keypad (not applicable for broadcasting messages).

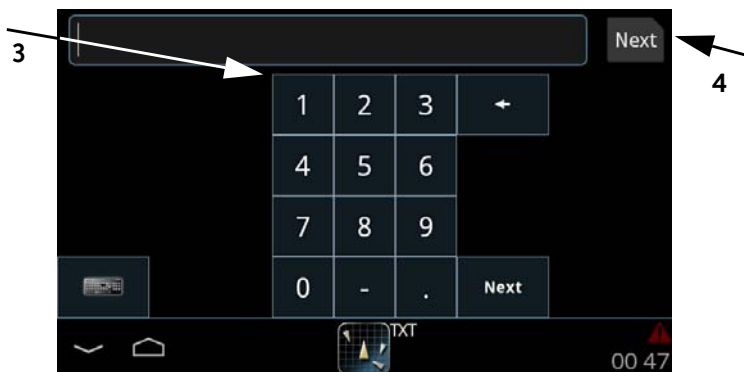

Figure 28: Entering MMSI number

4. Tap **Next** and enter the message text using the on-screen keyboard.
5. Tap **Done** or the symbol in the lower left corner to collapse the keyboard.



Figure 29: Writing a message

6. Tap **Send** to send the message. The message will be shown in the list of messages sent and received.

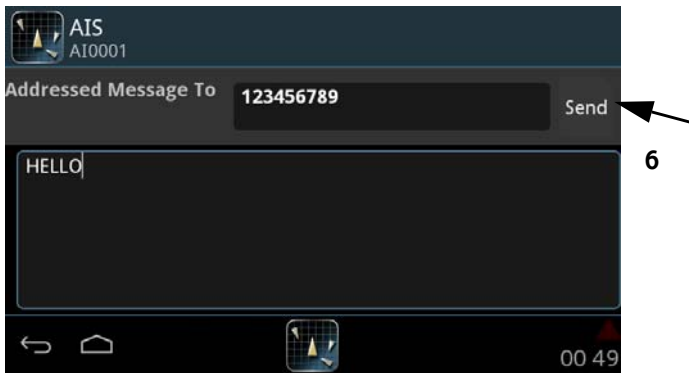

Figure 30: Sending a message

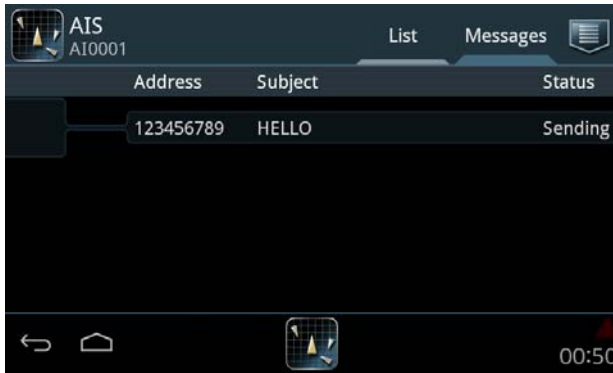

Figure 31: List of messages

A message sent by the SAILOR 6282 AIS Transponder can have one of the following states:

- Sending – The message is under transmission.
- Sent – The message has been sent completely.
- Delivered – The message is confirmed delivered to the receiving AIS but not necessarily read.

Viewing and replying to messages

If there are unread messages, icons appear in the bottom bar:

- Envelope with an exclamation mark: Unread safety-related messages 12 and 14
- Envelope without exclamation mark: Unread other messages

- White envelopes: New messages have arrived since this was checked the last time.

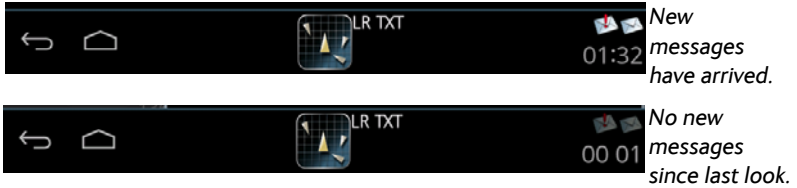

Figure 32: Icons for new messages

1. Tap the icon for unread messages to display the list of unread messages.



Figure 33: Viewing messages

If the received message is longer than one line in the display, the message is automatically split up into several lines.

2. Tap the message you want to read. The message opens and you can directly enter text and send a reply.

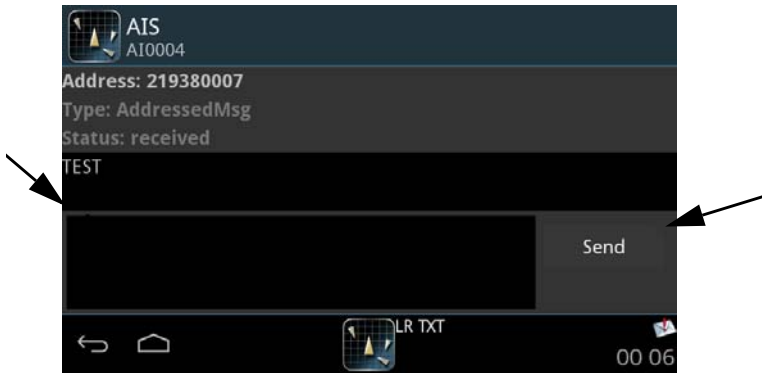

Figure 34: Replying to a message

When all messages are read, there is no envelope icon in the bottom bar.

Deleting messages

The latest 20 Safety Related Messages cannot be deleted. All other messages are deleted when the SAILOR 6282 AIS Transponder is restarted (power cycle).

Alarms and notifications

If an alarm is reported from the SAILOR 6282 AIS Transponder a flashing red triangle appears in the bottom bar of the SAILOR 6004 Control Panel display:

- Flashing, bright red triangle: Unacknowledged alarm(s).
- Faded red triangle: Acknowledged alarm(s).

To acknowledge an alarm do as follows:

1. Tap the flashing, bright red triangle to display the list with active alarms.
2. Tap the alarm to acknowledge the alarm.

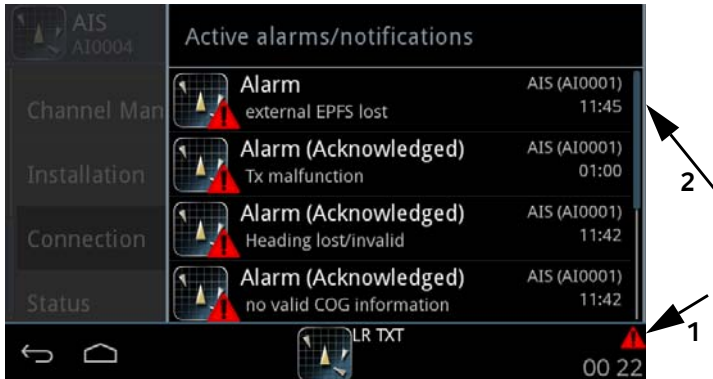

Figure 35: Active alarms

When all active alarms are acknowledged the bright red triangle turns into a faded red triangle.

Internal hardware errors in the SAILOR 6282 AIS Transponder are reported as Rx channel malfunction alarm messages. See Table 9 on page 41 for further details.

Alarms without time stamp

If the SAILOR 6004 Control Panel cannot retrieve the time for an alarm from the SAILOR 6282 AIS Transponder, this is marked by adding (CPT) to the alarm title. See the example in the following figure.

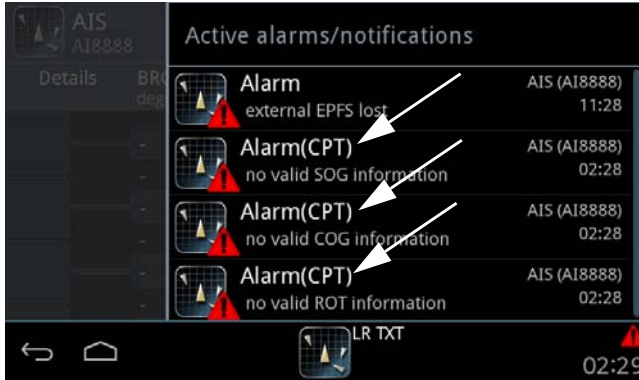

Figure 2-36: Active alarms, no time stamp from SAILOR 6282 AIS Transponder (example)

List of alarms

Alarm	Consequence	Reason	Remedy
Connection lost	AIS list is empty, the padlock for password protection cannot be opened.	Someone has logged into the TT-6282A AIS Service Interface. TRX has no power TRX-MKD connection cable is defect TRX lost Ethernet connection TRX or MKD use wrong connection settings.	After logout from the TT-6282A AIS Service Interface resumes normal operation. Allow up to 40 s to reboot.
Tx malfunction (ID 001)	The SAILOR 6282 AIS Transponder stops transmission.	The AIS is not able to transmit for technical reasons (VSWR exceeds allowed ratio, see alarm ID 002) Missing or invalid MMSI The integrity of the VDL is degraded by incorrect transmitter behaviour for instance in case of the Tx shutdown procedure has been activated.	Check the VHF antenna, plugs, and cable to the AIS Transponder. Check correct programming of the MMSI.
Antenna VSWR exceeds limit (ID 002)	The SAILOR 6282 AIS Transponder continues operation.	For every transmission, the VSWR is checked. If it exceeds the warning threshold, this alarm is generated. The alarm is cleared by the AIS when the VSWR is measured to be below the threshold again.	Check the VHF antenna, plugs, and cable to the AIS Transponder.

Table 9: AIS Alarms

Alarm	Consequence	Reason	Remedy
Rx channel AIS 1 malfunction (ID 003)	The SAILOR 6282 AIS Transponder stops transmission on the affected channel.	If continuous monitoring of the receiver channel 1 shows inconsistency, this alarm is activated.	Check the VHF antenna, plugs, and cable to the AIS transceiver.
Rx channel AIS 2 malfunction (ID 004)	The SAILOR 6282 AIS Transponder stops transmitting on the affected channel.	If continuous monitoring of the receiver channel 2 shows inconsistency, this alarm is activated.	Check the VHF antenna, plugs, and cable to the AIS Transponder.
Rx channel 70 malfunction (ID 005)	The SAILOR 6282 AIS Transponder continues operation, but external channel management is not possible.	If continuous monitoring of the receiver channels shows inconsistency, this alarm is activated.	Check the VHF antenna, plugs, and cable to the AIS Transponder.
General failure (ID 006)	The SAILOR 6282 AIS Transponder stops functioning. In case of severe software or hardware failure, this alarm is activated.		Check the power supply to the AIS Transponder.
UTC sync invalid (ID 007)	The SAILOR 6282 AIS Transponder continues operation using indirect or semaphore synchronization.	If the internal GNSS receiver cannot receive a synchronization signal from the satellites, this alarm is activated.	Check the GNSS antenna, plugs, and cable to the AIS Transponder.

Table 9: AIS Alarms (Continued)

Alarm	Consequence	Reason	Remedy
MKD Connection lost (ID 008)	The SAILOR 6282 AIS Transponder continues operation with DTE set to 1, the MKD is not active.	This alarm is activated by the system, if the AIS Transponder does not receive heartbeat messages from at least one minimum keyboard display (MKD) unit (e.g. SAILOR 6004 Control Panel).	Check the power supplies, cabling, Ethernet connection between the AIS Transponder and the SAILOR 6004 Control Panel. Restart both units: SAILOR 6282 AIS Transponder: remove and connect power, SAILOR 6004 Control Panel: use on/off button.
Internal / external GNSS position mismatch (ID 009)	The SAILOR 6282 AIS Transponder continues operation.	This alarm is activated when the distance between the external and internal GNSS position remains >100 m for an interval longer than 15 minutes.	Check the NMEA connection between external GNSS receiver and the AIS Transponder. Check as well the GNSS antenna, plugs, and cable to the AIS Transponder.

Table 9: AIS Alarms (Continued)

Alarm	Consequence	Reason	Remedy
NavStatus incorrect (ID 010)	The SAILOR 6282 AIS Transponder continues operation.	This alarm is activated if a mismatch exists between the sensor input and the Voyage settings status. E.g. when the status is set by the operator to At Anchor and the ship is moving faster than 3 kn, this alarm is activated.	Enter the AIS Application on the SAILOR 6004 Control Panel and set Status in Settings > Voyage to the correct state according to the ship's current movement.
Heading sensor offset (ID 011)	The SAILOR 6282 AIS Transponder continues operation.	This alarm is activated when SOG is greater than 5 kn and the difference between COG and HDT is greater than 45° for 5 min.	Check the heading sensor and its NMEA connection to the AIS Transponder.
Active AIS-SART (ID 014)	The SAILOR 6282 AIS Transponder continues operation.	This alarm is activated when the SAILOR 6282 AIS Transponder receives a position report from an AIS search and rescue transponder (SART). The AIS SART indicates the position of persons in distress. It is displayed on the first line in the AIS list view on the SAILOR 6004 Control Panel.	

Table 9: AIS Alarms (Continued)

Alarm	Consequence	Reason	Remedy
External EPFS lost (ID 025)	The SAILOR 6282 AIS Transponder continues operation, based on the internal GNSS.	The alarm is activated if the external electronic position fixing system (EPFS) is lost.	Check the NMEA connection between the external GNSS and the AIS Transponder.
No position sensor in use (ID 026)	The SAILOR 6282 AIS Transponder continues operation.	The alarm is activated in case none of the GNSS connected to the AIS Transponder provide valid position data to the AIS Transponder.	Check the GNSS antenna, plugs, and cable to the AIS. Check the NMEA connections between the external GNSS and the AIS Transponder. Check the status of the external GNSS at its own control panel. Check that the GNSS antennas are not covered and are free to receive satellite signals.

Table 9: AIS Alarms (Continued)

Alarm	Consequence	Reason	Remedy
No valid SOG information (ID 029)	The SAILOR 6282 AIS Transponder continues operation using default data.	This alarm is activated when none of the sensor inputs reports a valid speed over ground (SOG).	Check the NMEA connection between speed measuring device and AIS Transponder; check the GNSS antenna, plugs, and cable to the AIS Transponder; check the NMEA connection between the external GNSS receiver and the AIS Transponder.
No valid COG information (ID 030)	The SAILOR 6282 AIS Transponder continues operation using default data.	This alarm is activated when none of the sensor inputs reports a valid course over ground (COG).	In order to solve the problem, check the GNSS antenna, plugs, and cable to the AIS Transponder; check the NMEA connection between the external GNSS receiver and the AIS Transponder.
Heading lost/invalid (ID 032)	The SAILOR 6282 AIS Transponder continues operation using default data.	This alarm is activated when none of the sensor inputs reports a valid heading.	Check the NMEA connection between heading sensor and the AIS Transponder.

Table 9: AIS Alarms (Continued)

Alarm	Consequence	Reason	Remedy
No valid ROT information (ID 035)	The SAILOR 6282 AIS Transponder continues operation using default data.	This alarm is issued if the rate of turn (ROT) cannot be determined from sensor data or internal calculations.	Check the NMEA connection between ROT sensor and AIS transceiver; check the GNSS antenna, plugs, and cable to the AIS transceiver; check the NMEA connection between the external GNSS receiver and the AIS Transponder.
TX Silent Mode Active	The SAILOR 6282 AIS Transponder does not transmit.	This alarm is activated when the Silent Mode is selected.	The alarm is cleared when the Silent Mode is deselected.

Table 9: AIS Alarms (Continued)

Service & maintenance

This chapter has the following sections:

- *Maintenance*
- *Troubleshooting guide*
- *Service and repair*

Maintenance

Maintenance of the SAILOR 6282 AIS Transponder can be reduced to a maintenance check at each visit of the service staff. Inspect the unit for mechanical damages, salt deposits, corrosion and any foreign material. Due to its robust construction and ruggedness the unit has a long lifetime. Anyway it must carefully be checked at intervals not longer than 12 months – dependent on the current working conditions.

Contact for support

Contact an authorized dealer for technical service and support of the SAILOR 6282 AIS Transponder. Before contacting the authorized dealer you can go through the troubleshooting guide to solve some of the most common operational problems.

Software version

- SAILOR 6282 AIS Transponder: Tap **System > Applications > AIS**
- SAILOR 6004 Control panel: Tap **System > About > Version**

Service interface

All tasks related to installation, service and maintenance are described in the installation manual.

Only a service engineer can access the Service Interface directly from the display of the SAILOR 6004 Control Panel. This is useful for software update directly via the SAILOR 6004 Control Panel.

Do as follows:

1. From the list of messages, tap the menu icon and then **Settings**.
2. Tap the menu icon again, and swipe upwards.
3. Tap **Service Interface**.



Figure 37: Access the Service Interface

4. Tap **Yes** to continue.
5. The service engineer can now log in to the Service Interface.

Important

As long as the service engineer is logged into the Service Interface, the SAILOR 6282 AIS Transponder does not receive messages. The Control Panel application shows a Connection lost error.

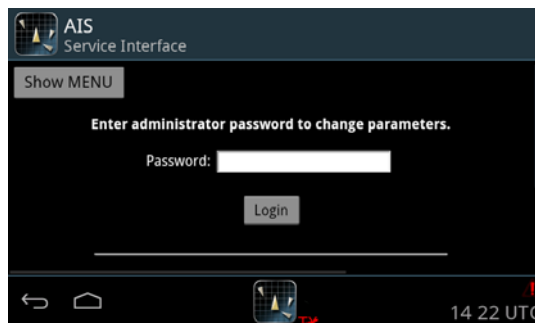

Figure 38: Login page of the Service Interface

System LEDs

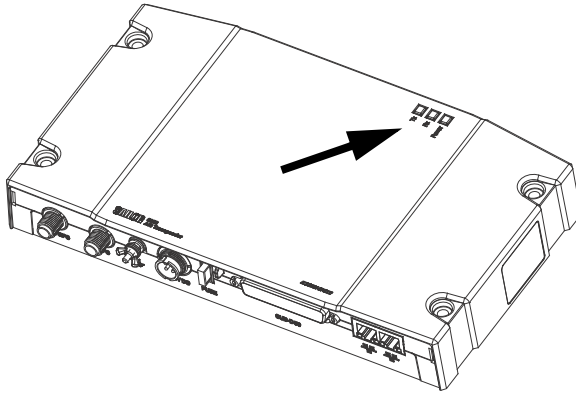

Figure 39: LEDs on the SAILOR 6282 AIS Transponder

LED	Colour	Description
Power	Green	Power on.
Rx	Yellow	Rx mode. Lights up when a message is received. Off when no activity.
Tx	Red	Tx mode. Lights up when a message is transmitted. Off when no activity.

Table 10: LEDs on the SAILOR 6282 AIS Transponder

App installation and system settings

The AIS app is installed in the SAILOR 6004 Control Panel during installation of the SAILOR 6280/6281 AIS System.

Having switched on the SAILOR 6004 Control Panel, an icon named **System** is always displayed, plus the icon(s) of the applications that are installed. Under **System** you can set up and manage the SAILOR 6004 Control Panel.



Figure 40: Screen to enter **System** (example)

Tap the icon **System** and the following topics are available:

- *Settings*
containing Network, Date/Time and Debugging.
- *Applications*
containing installed and available applications.
- *Self Test*
containing a self test of Touch, Controls Display, Audio, USB, Light Sensor, Alarm Output, NMEA and LAN.
- *About*
containing Legal information, software versions and network information (IP address and MAC address of the SAILOR 6004 Control panel).

Settings

Tap **Settings** to enter the section for network configuration, date and time setting and debugging. Tap the section you want to work with and explore the touch screen for each setting.

To change a setting you must enter the password for user level and tap **OK**.

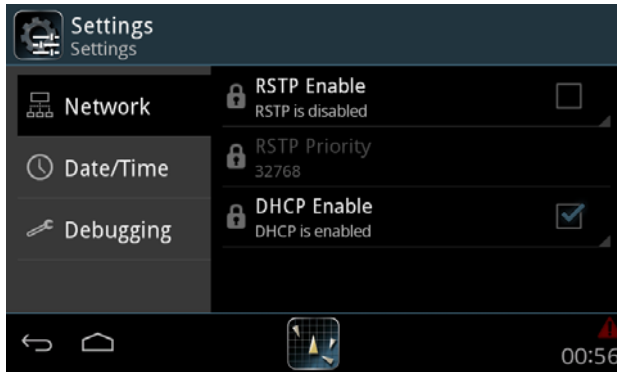

Figure 41: System - Settings, Display

Applications

Tap **Applications** to install or uninstall applications. This section has two tabs: **Available**, showing the apps that are available to the SAILOR 6004 Control Panel on the current network, and **Installed**, showing which apps are already installed.

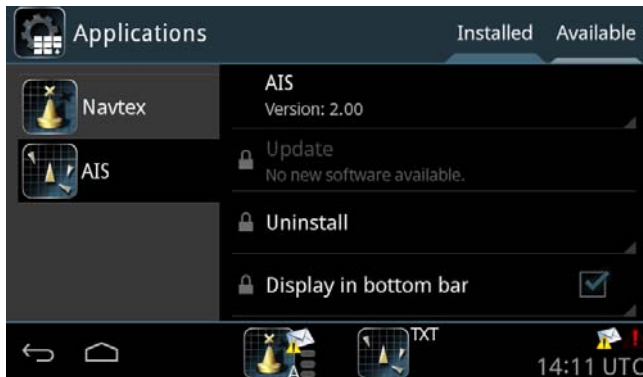

Figure 42: System – Applications (example)

To install an app, do as follows:

1. Tap **Available** to display the apps that are available to this SAILOR 6004 Control Panel.
2. Tap the app you want to install.
For each app there are the following items:
 - App name and version, e.g. AIS Version 2.0.
 - **Install** to install this app on the SAILOR 6004 Control Panel.
3. Enter the password for user level and tap **OK**.

To manage an already installed app, do as follows:

1. Tap **Installed** to display the apps that are installed on this SAILOR 6004 Control Panel.
2. Tap the app you want to manage.
For each app there are the following items:
 - App name and version, e.g. AIS Version 2.0.
 - **Update** (if available, else grayed out) – tap here to update this app.
Enter the password for user level and tap **OK**.
 - **Uninstall** – tap here to uninstall this app from the SAILOR 6004 Control Panel.
 - **Display in bottom bar** – tap here and select or deselect whether the app should be visible in the bottom bar of the SAILOR 6004 Control Panel.

You must enter the password for user level (user) and tap **OK**.

Self Test

Tap **Self Test** to start the self test of the SAILOR 6004 Control Panel. For further details on the self test see the installation manual of the SAILOR 6004 Control Panel.

About

Tap About to view the following:

- **Legal** with legal and copyright information, open source licences, etc.
- **Version** with various software versions and serial number of the SAILOR 6004 Control Panel.
- **Network** with IP address and MAC address of the SAILOR 6004 Control Panel.

Troubleshooting guide

Problem	Symptom	Remedy
The SAILOR 6282 AIS Transponder will not turn on.	Green LED on SAILOR 6282 AIS Transponder is off.	If the power cable is connected directly to the SAILOR 6282 AIS Transponder then check that the white wire in the power cable is connected to the black wire (-DC). If power to SAILOR 6282 AIS Transponder is connected via the connection board then check the jumper W8 is placed in position AIS ON . For further details see the Installation manual.
No communication	No flashing yellow or red LED on AIS transponder	Check if a valid MMSI has been entered. For further details see the installation manual.
No GPS	No signal from GPS. Position requested.	Check the antenna cable to the GPS.
Missing MMSI		When powering up the SAILOR 6282 AIS Transponder for the first time after leaving the factory there is no MMSI stored in the SAILOR 6282 AIS Transponder. Enter a valid MMSI to operate the SAILOR 6282 AIS Transponder. For further details see the Installation manual.
Wrong MMSI		If a wrong MMSI number has been entered and stored, or if there is a requirement to change it, contact your authorized dealer.

Table 11: Troubleshooting guide

Problem	Symptom	Remedy
Device failure		If any of the checks and tests described in this section do not assist in resolving the difficulties experienced in the operation and/or performance of the AIS installation, a fault may have developed in the AIS System. When contacting an authorized representative be sure to provide as much information as possible describing the observed behaviour - also including the type of the AIS units, serial number, and software release version. You find this information in the setup menu of the connected SAILOR 6004 Control Panel.
SAILOR 6004 Control Panel cannot be switched off.		If the SAILOR 6004 Control Panel cannot be switched off normally (e.g. due to a fault): Push and hold for 12 seconds.
Password entered, but padlock does not open	Authorization failed. Wrong password or the connection to the SAILOR 6282 AIS Transponder is lost	<p>Check that you enter the correct password.</p> <p>Check the power supplies, cabling, Ethernet connection between the AIS transceiver and the SAILOR 6004 Control Panel. Restart both units: SAILOR 6282 AIS Transponder: remove and connect power, SAILOR 6004 Control Panel: use on/off button.</p> <p>Check that no one has logged into the Service Interface.</p>
The Test Message does not pass.		If you do not receive an answer within 30 seconds try the test with another ship.

Table 11: Troubleshooting guide (Continued)

Service and repair

Should your Cobham SATCOM product fail, please contact your dealer or installer, or the nearest Cobham SATCOM partner. You will find the partner details on www.cobham.com/satcom where you also find the Cobham SATCOM Self Service Center web-portal, which may help you solve the problem.

Your dealer, installer or Cobham SATCOM partner will assist you whether the need is user training, technical support, arranging on-site repair or sending the product for repair.

Your dealer, installer or Cobham SATCOM partner will also take care of any warranty issue.

Applicable SAILOR and part numbers

This installation manual is for the SAILOR 6280/6281 AIS System and is applicable to the part numbers below:

Part number	Description
406282A	SAILOR 6282 AIS Transponder
406004A	SAILOR 6004 Control Panel
406285A	SAILOR 6285 GPS Antenna - Active
406283A	SAILOR 6283 AIS Connection Box and Wall Tray

Table 12: Part numbers for the SAILOR 6280/6281 AIS System

Accessories

The following accessories are included in the delivery:

Part number	Description accessories
37-130130	DC Power cable for SAILOR 6282 AIS Transponder and SAILOR 6004 Control Panel
37-135955	SUB-D50 cable, 1 m
37-207073-000	RJ45 Cat5e STP LAN cable, 5 m
41-135855	GPS Antenna bracket
67-135974	Pilot plug

Table 13: Part numbers for accessories

Replacing the fuse

One fuse is installed in the SAILOR 6282 AIS Transponder. If this fuse is blown, do as follows:

1. Track down why the fuse was blown and solve the problem.
2. Take out the old fuse. Use the fuse puller.
3. Insert the new fuse. The fuse rating is 5 A T.

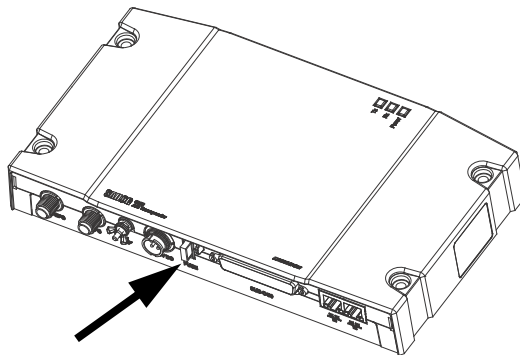

Figure 43: 5 A T fuse in the SAILOR 6282 AIS Transponder

Repacking for shipment

Should you need to send the product for repair, please read the below information before packing the product.

The shipping carton has been carefully designed to protect the SAILOR 6282 AIS Transponder and its accessories during shipment. This carton and its associated packing material should be used when repacking for shipment. Attach a tag indicating the type of service required, return address, part number and full serial number. Mark the carton FRAGILE to ensure careful handling.

Note | Correct shipment is the customer's own responsibility.

If the original shipping carton is not available, the following general instructions should be used for repacking with commercially available material.

1. Wrap the defective unit in heavy paper or plastic. Attach a tag indicating the type of service required, return address, part number and full serial number.
2. Use a strong shipping container, e.g. a double walled carton.
3. Protect the front- and rear panel with cardboard and insert a layer of shock-absorbing material between all surfaces of the equipment and the sides of the container.
4. Seal the shipping container securely.
5. Mark the shipping container FRAGILE to ensure careful handling.

Failure to do so may invalidate the warranty.

Specifications

SAILOR 6282 AIS Transponder

Item	Specification
Weight	1.15 kg
Dimensions (L x W x H)	160 x 270 x 42 mm
Equipment class	Protected, according to IEC 60945
Input voltage	10.8 VDC to 31.2 VDC
Power consumption	12 W (0.5 A @24 VDC input voltage)
Heat dissipation	10 W
Temperature	-15 °C to +55 °C (Operational) -30 °C to +70 °C (Storage)
Compass Safe Distance	55 cm (standard magnetic compass) 45 cm (Emergency magnetic compass)
Receivers	156.025 - 162.025 MHz (TDMA) 156.525 MHz (Channel 70, DSC)
Channel bandwidth	25 kHz
RF Output Power	High: 12.5 W Low: 1 W Low power forced control (gas alarm): 1 W
Frequency	156.025 - 162.025 MHz
VHF connector	TNC female

Table 14: SAILOR 6282 AIS Transponder specifications

Item	Specification
GPS connector	TNC female
VHF and GPS cable	RG214 or better
Connection to SAILOR 6004 Control Panel	LAN (LWE IEC 61162-450)
Connections to sensors and PI	50 pin sub-D

Table 14: SAILOR 6282 AIS Transponder specifications

Reporting Intervals

The SAILOR 6282 AIS Transponder is transmitting in different intervals depending of the dynamic input data as speed and turn. The reporting intervals are as follows:

Type of information	Reporting interval
Static Information	Every 6 min. or when data has been amended and on request.
Dynamic Information	Depending on speed and course alteration, see the table below.
Voyage related information	Every 6 min. or when data has been amended and on request.
Safety related message	As required.

Table 15: Reporting intervals

Type of ship	Reporting Interval
Ship at anchor or moored and not moving faster than 3 knots	3 min
Ship at anchor or moored and moving faster than 3 knots	10 s
Ship with a speed of between 0 - 14 knots	10 s
Ship with a speed of between 0 - 14 knots and changing course	3 1/3 s
Ship with a speed of between 14 - 23 knots	6 s
Ship with a speed of between 14 - 23 knots and changing course	2 s
Ship with a speed of greater than 23 knots	2 s
Ship with a speed of greater than 23 knots and changing course	2 s

Table 16: Reporting intervals for types of ship

SAILOR 6285 GPS Antenna - Active

Item	Specification
Dimensions	Ø: 91 mm, H: 77.5 mm
Weight	0.15 kg
Mounting	Bracket mount on pipe, thread 1" x 14 TPI
Equipment class	Exposed, according to IEC 60945
Antenna type	Active patch antenna
Frequency	1570 to 1608 MHz
Impedance	Nominal 50 Ohm
Polarization	Circular right-hand
Coverage	Hemispherical
Selectivity	45 dB down at center ± 25 MHz
Gain	28 dB
Supply voltage	5 ± 1 VDC
Current consumption	Approx. 30 mA
Connector	TNC female
Cable	RG214 recommended
Operating temperature	-40 °C to +55 °C
Storage temperature	-40 °C to +70 °C

Table 17: SAILOR 6285 GPS Antenna - Active specifications

SAILOR 6283 AIS Connection Box and Wall Tray

Item	Specification
Weight without SAILOR 6282 AIS Transponder	2.15 kg
Weight with SAILOR 6282 AIS Transponder mounted	3.30 kg
Dimensions (L x W x H)	340 x 310 x 55 mm
Equipment class	Protected, according to IEC 60945
Compass Safe Distance	55 cm (standard magnetic compass) 45 cm (Emergency magnetic compass)

Table 18: SAILOR 6283 AIS Connection Box and Wall Tray specifications

SAILOR 6004 Control Panel

Item	Specifications
Mounting method	Flush mount or bracket
Voltage	10.8 to 31.2 VDC
Power consumption	Typical: 18 W active Peak: 42 W 3.15 A internal fuse (non-serviceable)
Audio input	Up to 6 W in 8 Ohm
Interfaces	2 x Ethernet (10/100 Mbit/s) Accessories connector Auxiliary connector

Table 19: SAILOR 6004 Control Panel specifications

Item	Specifications
Compliance	<ul style="list-style-type: none"> • IEC 60945 • IEC 60950-1
IP rating	IP54 ^a
Ambient temperature	-15 °C to 55 °C
Storage temperature	-30 °C to 80 °C
Compass safe distance	0.6 m
Dimensions W x H x D	191 mm x 145 mm x 61 mm (without mounting bracket)
Weight	1.1 kg (1.25 kg with mounting bracket)

Table 19: SAILOR 6004 Control Panel specifications (Continued)

a. Estimated.

NMEA sentences

Sentences defined in IEC 61993-2

IEC 61993-2 sentence	Support
IEC 61162-1 sensor sentences	DTM, GBS, GGA, GNS, HDT, RMC, ROT, THS, VBW, VTG
AIS High-speed input data and formats	ABM, ACA, AIR, BBM, EPV, HBT, LRF, SPW, SSD, VSD
AIS high speed output data and formats	ABK, ACA, EPV, LRF, NAK, VER, SSD, TXT, VDM, VDO, VSD,
AIS Long-Range communications input data and formats	LRI, LRF
LR output data formats	LR1, LR2, LR3, LRF, LRI
Optional PI port sentences	EPV, SPW, TRL
Transmission of binary Message 25 and 26	ABM, BBM, ABK

Table 20: Supported NMEA sentences IEC 61993-2

Sentences defined by Cobham SATCOM

Proprietary protocol.

- PIWWIVD
- PIWWSSD
- PTHRAOC
- PTHRROS
- PTHRSNR

A

AIS SART	AIS Search And Rescue Transmitters
AIS	Automatic Identification System

C

CCNR	Central Commission for Navigation on the Rhine, an international organization whose function is to encourage European prosperity by guaranteeing a high level of security for navigation of the Rhine and environs.
COG	Course Over Ground

D

DGNSS	Differential Global Navigational Satellite System
DSC	Digital Selective Calling. Primarily intended to initiate ship-to-ship, ship-to-shore and shore-to-ship radiotelephone and MF/HF radiotelex calls. Each DSC-equipped ship, shore station and group is assigned a unique 9-digit Maritime Mobile Service Identity. DSC distress alerts, which consist of a preformatted distress message, are used to initiate emergency communication with ships and rescue coordination centers.
DTE	Data Terminal Equipment

E

ECDIS	Electronic Chart Display and Information System (ECDIS) is a computer-based navigation information system that complies with International Maritime Organization (IMO) regulations and can be used as an alternative to paper nautical charts.
-------	--

G

GLONASS	GLObal'naya NAVigatsionnaya Sputnikovaya Sistema. Global Navigation Satellite System in English.
---------	--

GNSS	Global Navigational Satellite System
GPL	General Public License
GPL	General Public License, software license, which guarantees individuals, organizations and companies the freedom to use, study, share (copy), and modify the software.
GPS	Global Positioning System. A system of satellites, computers, and receivers that is able to determine the latitude and longitude of a receiver on Earth by calculating the time difference for signals from different satellites to reach the receiver.

H

HDT	HeaDing True
-----	--------------

I

IEC	International Electrotechnical Commission. The international standards and conformity assessment body for all fields of electrotechnology.
IMO	International Maritime Organization
INS	Integrated Navigation System
IP	Ingress Protection. An international classification system for the sealing effectiveness of enclosures of electrical equipment against the intrusion into the equipment of foreign bodies (i.e. tools, dust, fingers) and moisture. This classification system uses the letters "IP" followed by two or three digits. An "x" is used for one of the digits if there is only one class of protection; e.g. IPX4 which addresses moisture resistance only.

L

LAN	Local Area Network
LGPL	Lesser General Public License

LWE LightWeight Ethernet

M

MKD Minimum Keyboard Display

MMSI MMSI Maritime Mobile Service Identity. A series of nine digits which are sent in digital form over a radio frequency channel in order to uniquely identify ship stations, ship earth stations, coast stations, coast earth stations, and group calls. These identities are formed in such a way that the identity or part thereof can be used by telephone and telex subscribers connected to the general telecommunications network to call ships automatically.

MPE Maximum Permissible Emission

N

NMEA National Marine Electronics Association (standard). A combined electrical and data specification for communication between marine electronic devices such as echo sounder, sonars, anemometer (wind speed and direction), gyrocompass, autopilot, GPS receivers and many other types of instruments. It has been defined by, and is controlled by, the U.S.-based National Marine Electronics Association.

P

PI Presentation Interface

R

RAIM Receiver Autonomous Integrity Monitoring. Integrity check of the position.

RF Radio Frequency

ROT Rate Of Turn

S

SART	Search And Rescue Transponder
SOG	Speed Over Ground.
SOLAS	(International Convention for the) Safety Of Life At Sea. Generally regarded as the most important of all international treaties concerning the safety of merchant ships.
SRM	Safety Related Messages

T

TDMA	Time-Division Multiple Access
TPI	Threads Per Inch

U

UTC	Universal Time, Coordinated. The International Atomic Time (TAI) with leap seconds added at irregular intervals to compensate for the Earth's slowing rotation. Leap seconds are used to allow UTC to closely track UT1, which is mean solar time at the Royal Observatory, Greenwich.
-----	--

V

VDL	VHF Data Link
VHF	Very High Frequency. 30-300 MHz, a "straight-line" signal used for short-distance terrestrial communication and navigation.
VSWR	Antenna Voltage Standing Wave Ratio
VTS	Vessel Traffic Service, a marine traffic monitoring system established by harbour or port authorities, similar to air traffic control for aircraft.

A

- accessories, 59
- AIS
 - channel change, 28
 - introduction, 1
 - software version, 49
- alarm, 39
 - output, 6
- alarms, 41
- antenna, combined, 6
- app
 - display in bottom bar, 54
- applications, 53

B

- bearing value, 11
- Blue sign, 6
- bottom bar, 54
 - display app, 54
- brightness, 13
- buzzer, 7

C

- cargo, 17
- change AIS channel, 28
- channel management, 28
- Com test, 27
- compass safe distance, iii, 66
- connection box, 6
- Control Panel
 - software version, 49

D

- DGNSS, 20
- dimensions, 66
- dimming function, 13
- display
 - brightness, 13
- display in bottom bar, 54
- document number
 - this manual, i
- draught, 18

E

- ETA, 17

F

- fuse, 65
 - rating, 59
 - replace, 59

G

- gas alarm, 6
- GNSS signal level, 30
- GPS
 - no fix, 30
 - signal level, 30
- GPS antenna position
 - external, 22
 - internal, 22

I

- icon in bottom bar, 54
- idle screen, 10
 - sort lists, 13
- IEC 61993-2
 - sentences, 67
- IMO number, 21
- install app, 53
- IP address, 30
 - Control Panel, 55

L

- LED
 - Power, 51
 - Rx, 51
 - Tx, 51
- license
 - software, ii
- LO, 12
- Long Range, 25
 - message, read, 25
 - satellite tracking, 6
- low power forced control, 6
- LR, 12

M

- MAC address
 - Control Panel, 55

manual
document number, i

message
SART, 33
unread, 12

MMSI
Missing MMSI, 56
number, 21
wrong MMSI, 56
model numbers, 58

N

night mode, 7, 13
NMEA interface versions, 5
NMEA sentences, 67
Cobham SATCOM, 67
IEC 61993-2, 67

O

open source licences, 55

P

padlock, 16
parameters
set, 15
part numbers, 58
accessories, 59
password, 16
pilot plug, 6
pirat mode, 31
Power LED, 51
presentation interfaces, 6

R

radar, 3
range, 11
reporting interval, 62
RF exposure, iii
ROT, 6
Rx LED, 51

S

safety distance, iii

SART messages, 33
self test, 54
sensor inputs, 6
sentences
IEC 61993-2, 67
proprietary, 67
settings, 15
ship details, 14
silent mode, 12, 31
software
uninstall, 54
software license, ii
software version
AIS, 49
Control Panel, 49
SOG/COG
internal or external, 20
sorting lists in idle view, 13
status, 20

T

ThranelINK, 5
time, 12
troubleshooting, 56
Tx LED, 51
TX off, 12
TXT, 12

U

uninstall, 54
unread messages, 12

V

VTS tool, 2

W

warranty, iii, 58
waterproof, iii

